



### Model Number

**V15-W-BK5M-PUR-A**

Female cordset, M12, 5-pin, PUR cable

### Features

- Improved resistance to weld slag
- Appropriate for conveyor chains
- Suitable for robotic applications / torsion resistant
- Flame resistant cable
- Halogen-free
- Resistant to microbes and hydrolysis
- Free of paint coating substances
- Immunity to vibration, with mechanical latching
- Knurled nut suitable for tool assembly

### Dimensions

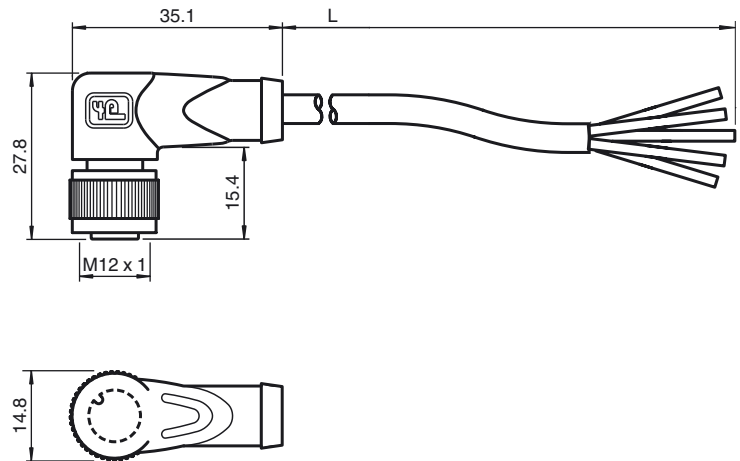

### Technical data

#### General specifications

Number of pins	5
Connection 1	socket
Construction type 1	right angle
Threading 1	M12
Connection 2	cable end
UL File Number	E231213

#### Electrical specifications

Operating voltage	$U_B$	max. 60 V AC/DC
Operating current		max. 4 A

#### Ambient conditions

Ambient temperature	Body: -40 ... 90 °C (-40 ... 194 °F) cable, fixed: -40 ... 80 °C (-40 ... 176 °F) cable, flexing: -25 ... 80 °C (-13 ... 176 °F)
Pollution Degree	3

#### Mechanical specifications

Contact elements	spring-loaded contact socket
Pin diameter	1 mm
Protection degree	IP67 / IP68 / IP69k
Material	
Contacts	CuSn / Au
Contact surface	Au
Body	TPU, black
Cable	PUR
Slotted nut	Diecast zinc
Core insulation	PP
Cable	extra-fine wire, flexible
Sheath diameter	Ø 4.7 mm
Drag chain cycles	≥ 5000000 (at max. 60 °C)
Bending radius	> 10 x cable diameter, moving > 5 x cable diameter, fixed
Motion velocity	≤ 3.3 m/s
Traverse distance	5 m horizontal
Acceleration	≤ 5 m/s <sup>2</sup>
Torsion cycles	≥ 1000000 (at max. 60 °C)
Torsional stress	± 180 °/m
Color	black
Cores	5 x 0.34 mm <sup>2</sup>
Conductor construction	42 x 0.1 mm Ø
Length	L 5 m
Flammability	
Contact material	HB
Housing	V-2
Cable	FT2

### Electrical connection

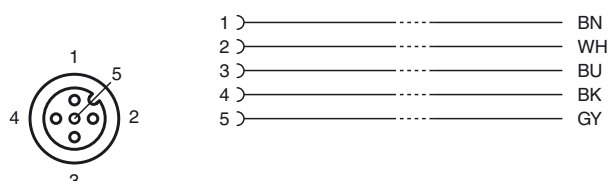



**Compliance with standards and directives**

Standard conformity

Protection degree	EN 60529:2000
Standards	IEC 61076-2-101:2008
Flammability	Grip: UL 94 Cable: UL 758 / UL 1581
Halogen-free	IEC 60754-1:1994/DIN VDE 0472-815

**Approvals and certificates**

UL approval	UL Recognized General purpose
-------------	-------------------------------

Release date: 2013-07-18 13:15 Date of issue: 2013-07-18 257412\_eng.xml